

# DALLAS

## KOMODA D-2

# INSTRUKCJA MONTAŻU

Narzędzia potrzebne do montażu

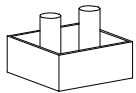
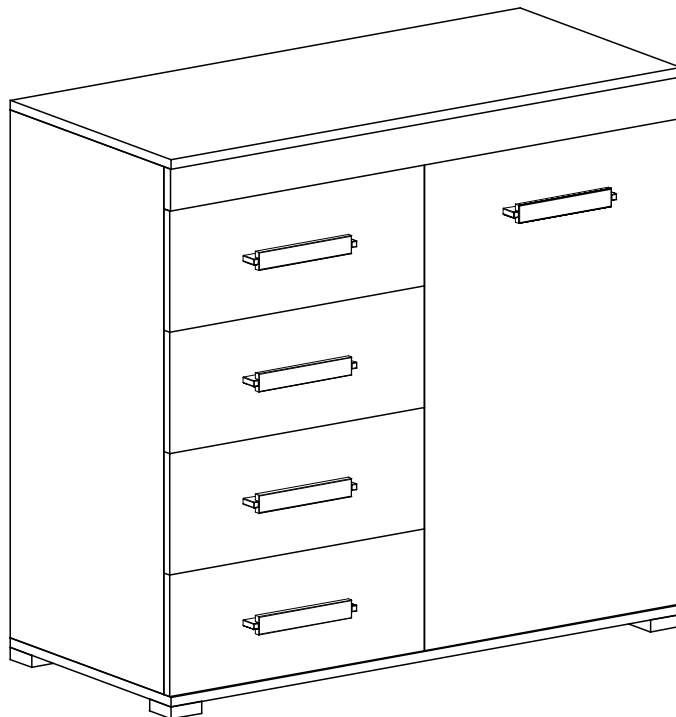
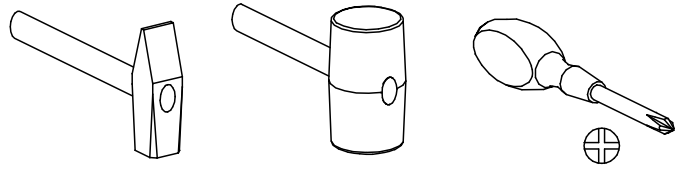
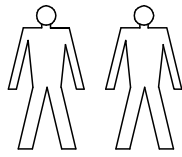
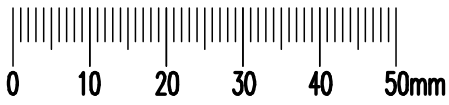

R-4 St.

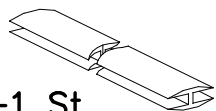

H-1 St.

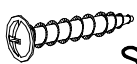

S-10 St.  
4x27

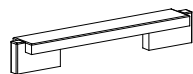

U-5 St.

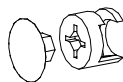

K-25 St.

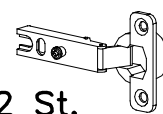

D-2 St.



Y-1 St.



E-80 St.

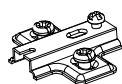

C-2 St.

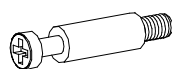

N-25 St.

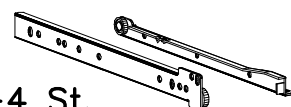

J-4 St.

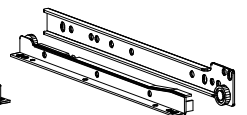

P-8 St.

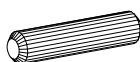

B-32 St.



G-16 St.



Z-36 St.  
3,5x16

I

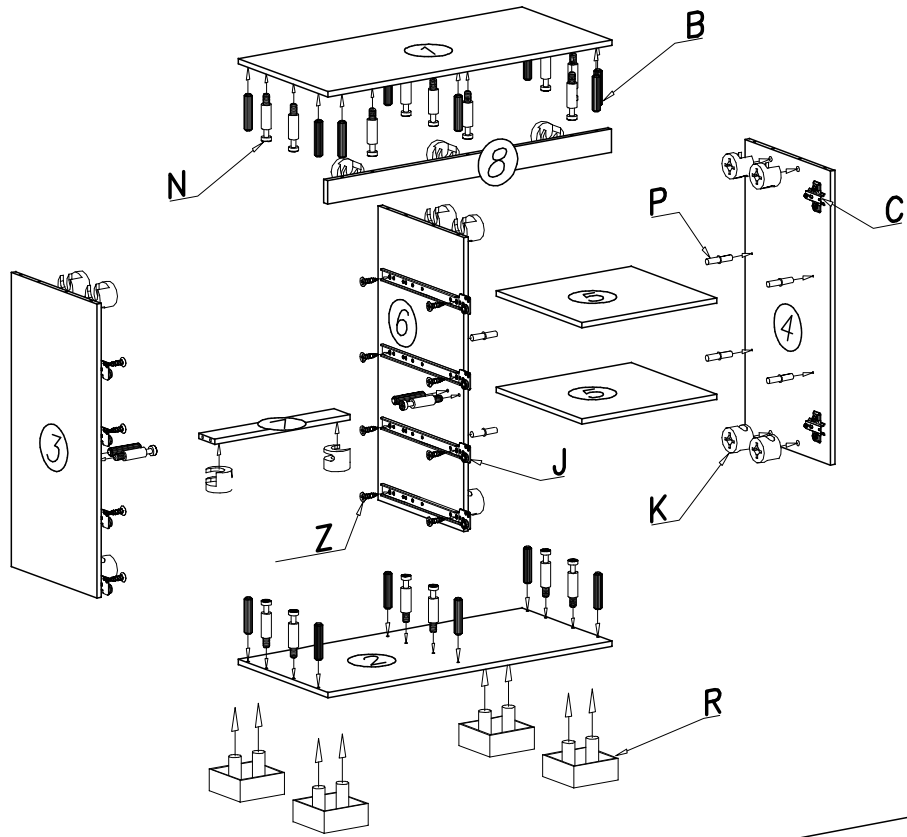

II

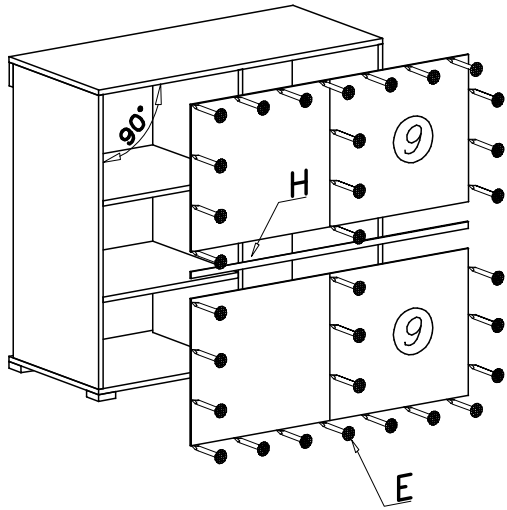

III

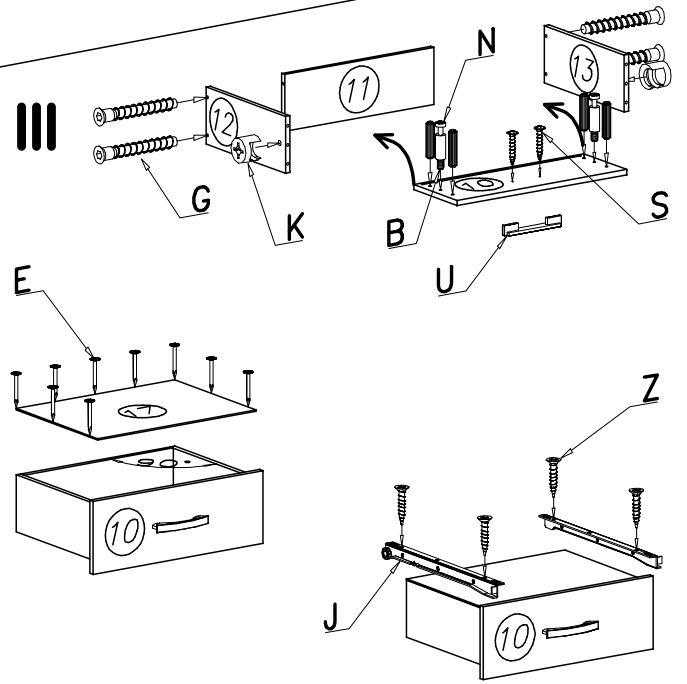

IV

