

# system GREY

G-09

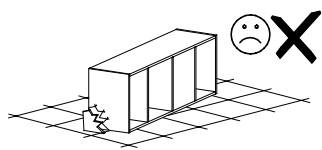

Narzędzia potrzebne do montażu

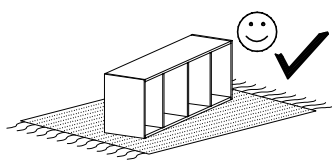
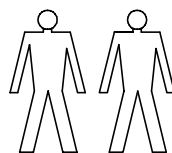
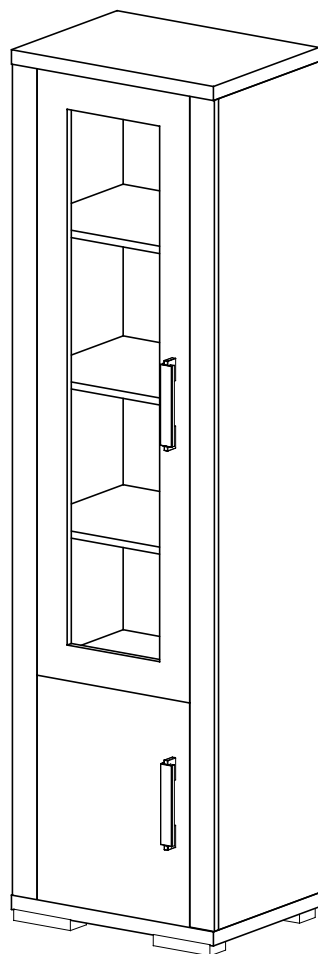
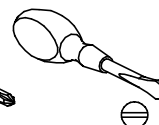
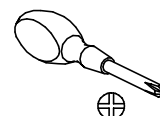
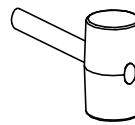
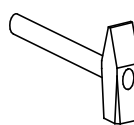

lewa  
lub  
prawa

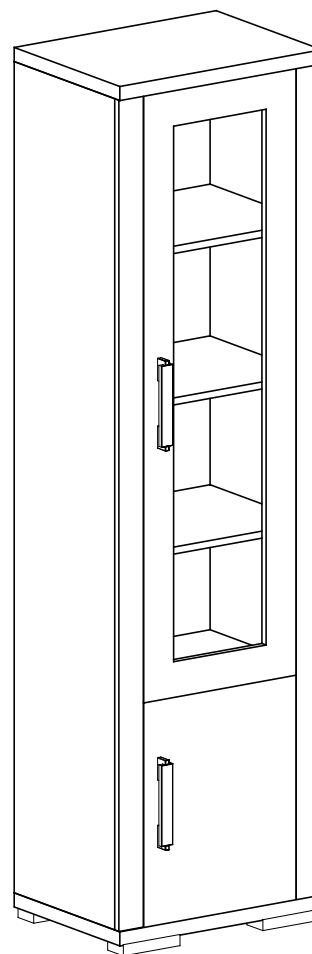

R-2 St.

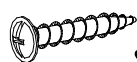

S-4 St.  
4x27

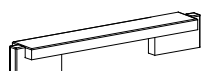

U-2 St.

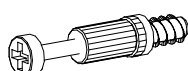

N-20 St.

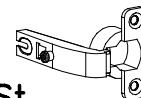

D-5 St.

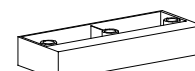

A-2 St.



E-45 St.

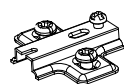

C-5 St.

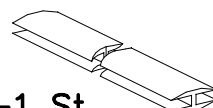

H-1 St.



P2-2 St.



K-10 St.  
4x30



P1-12 St.

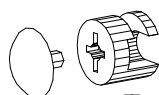

T-20 St.



B-22 St.

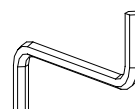

Y-1 St.



Z-10 St.  
3,5x16

I

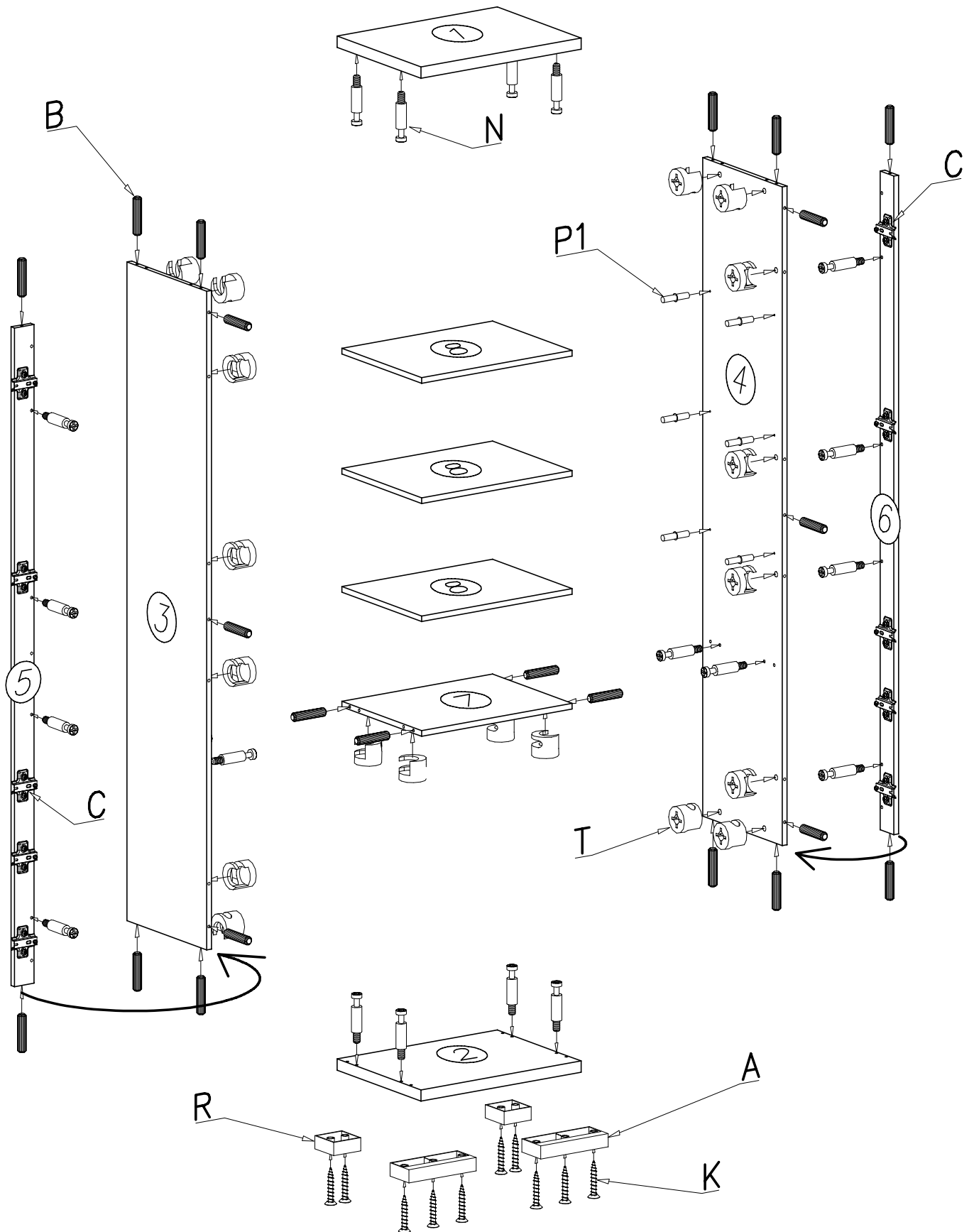

Okucie "C" proszę przykręcić do listwy nr 5 jeżeli chcecie aby drzwi się otwierały na lewą stronę, lub do listwy nr 6 jeżeli drzwi mają otwierać się na prawą stronę.

II

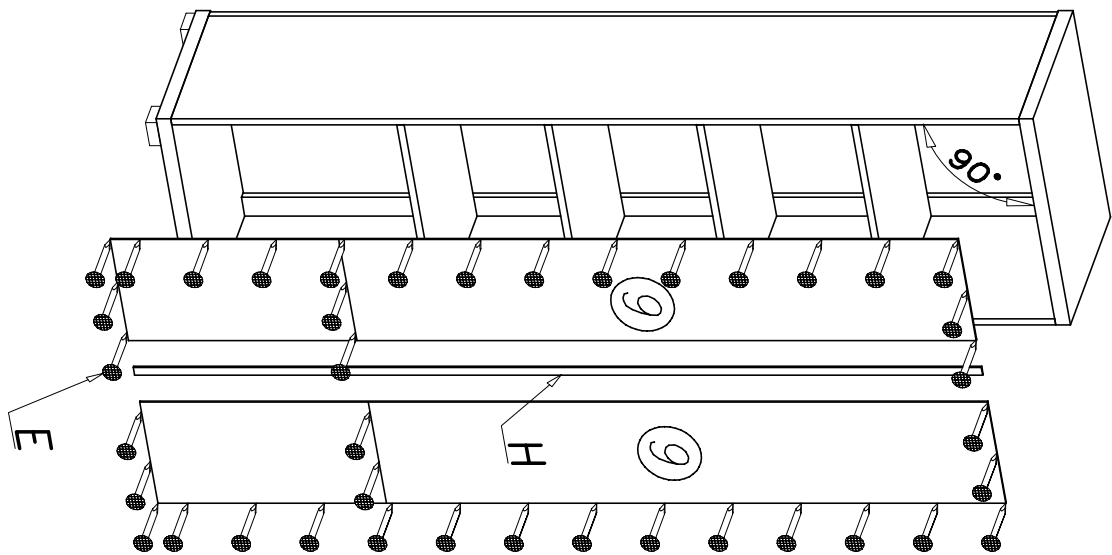

III

drzwi lewe lub prawe

