

M-12

RTV 150

INSTRUKCJA MONTAŻU

Narzędzia potrzebne do montażu

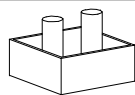
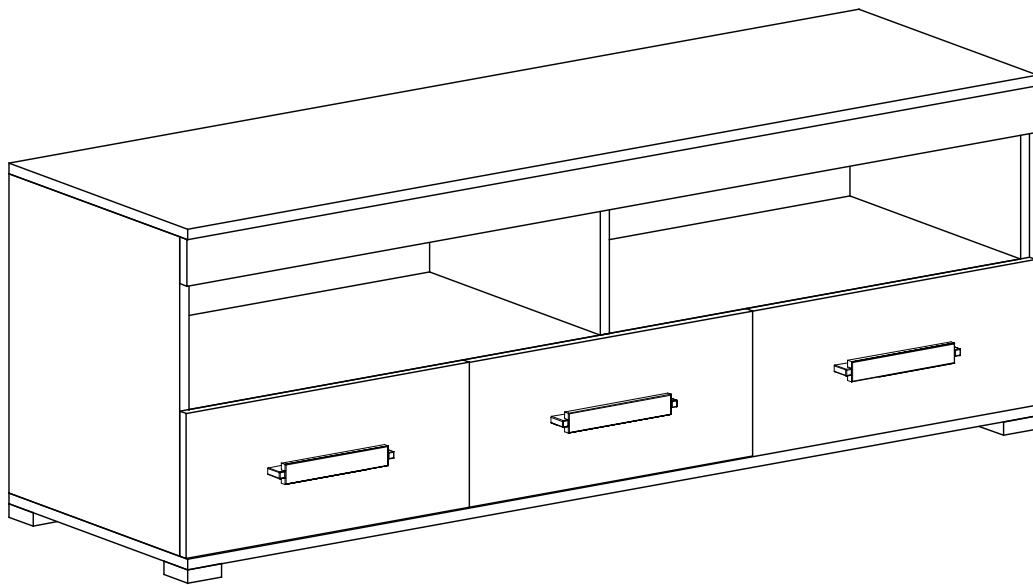
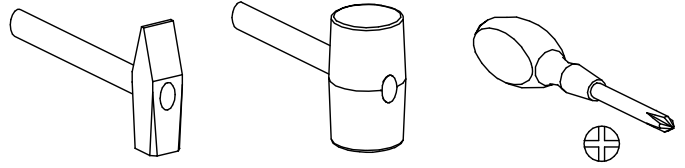
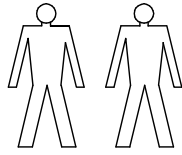
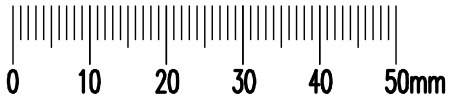

R-8 St.

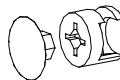

K- 32 St.



D-15 St.

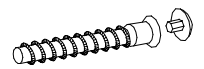

G- 14St.

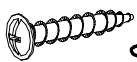

S-6 St.
4x27

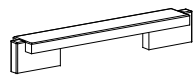

U-3 St.

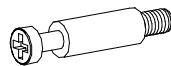

N- 32 St.

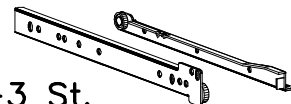

J-3 St.

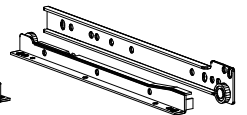

Z-24 St.
3,5x16



E-80 St.



B-47 St.

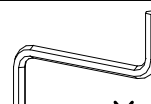

Y-1 St.

