

M-18

Regał z Drz 80

INSTRUKCJA MONTAŻU

Narzędzia potrzebne do montażu

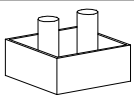
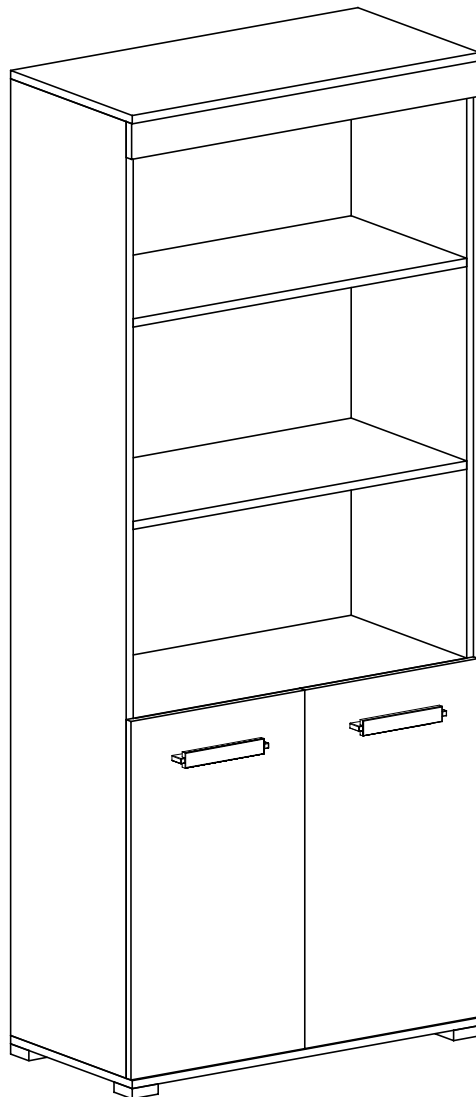
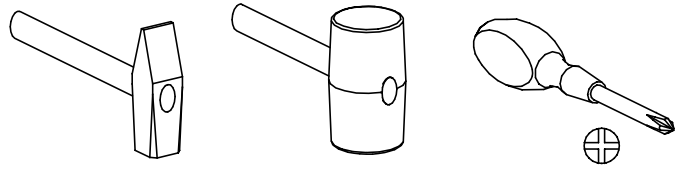
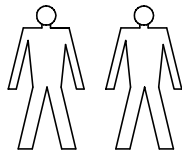
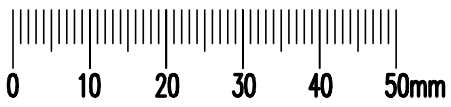

R-4 St.

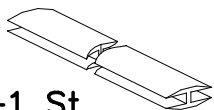

H-1 St.

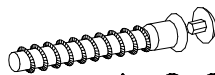

A-8 St.

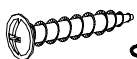

S-4 St.
4x27

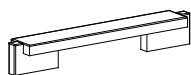

U-2 St.

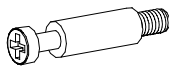

N-7 St.

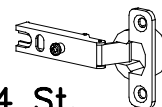

D-4 St.



G-8 St.
3,5x16



E-60 St.

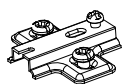

C-4 St.

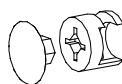

K-7 St.



B-14 St.

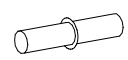

P-12 St.

I

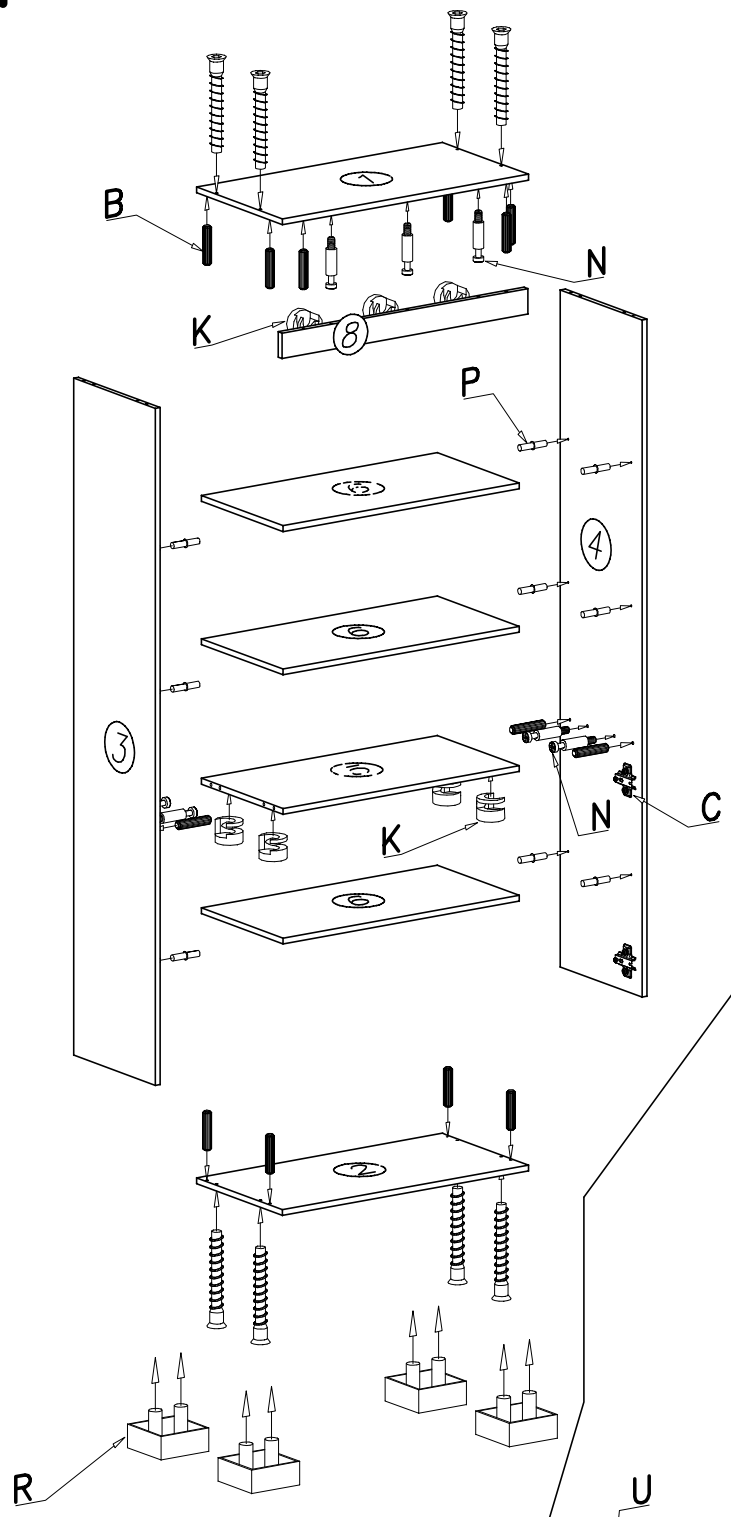

II

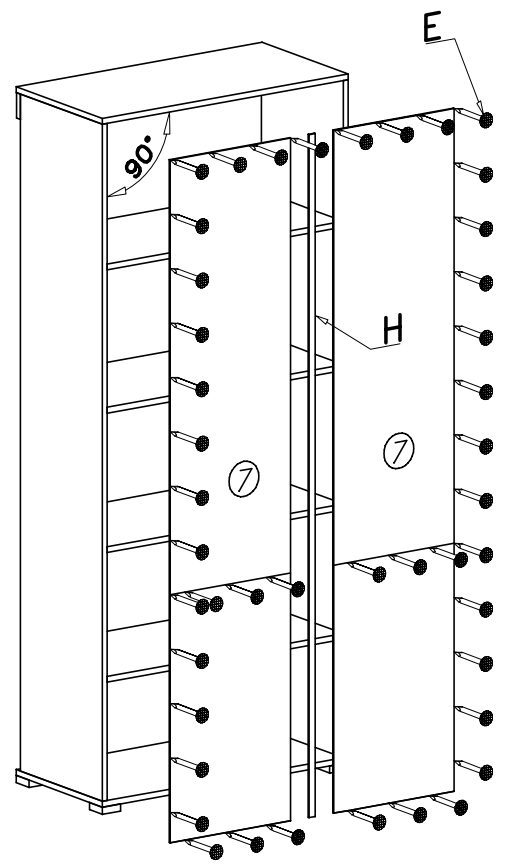

III

