

M-21/150

INSTRUKCJA MONTAŻU

Narzędzia potrzebne do montażu

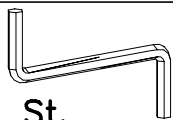
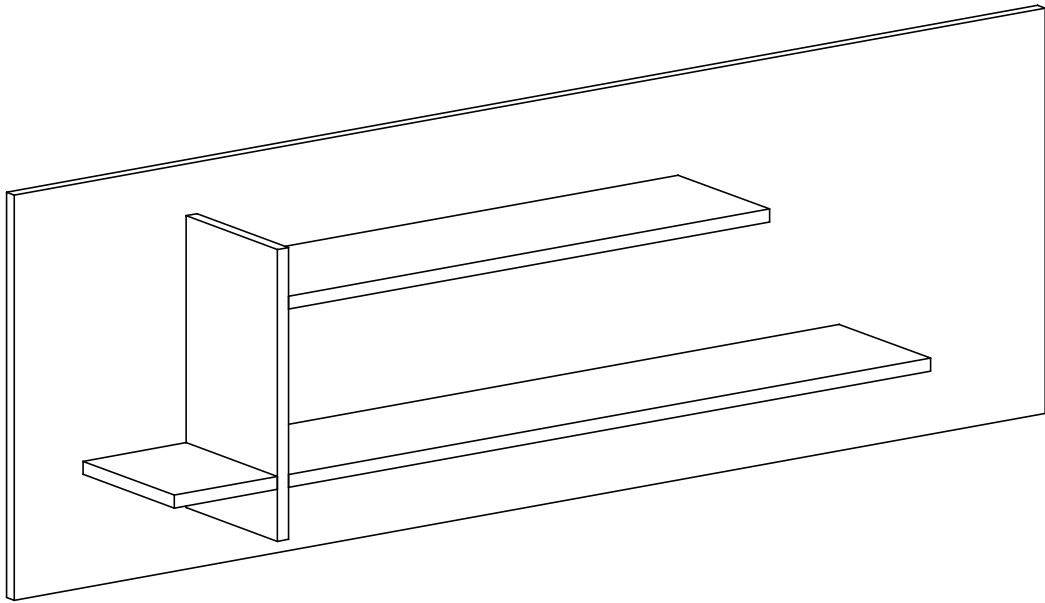
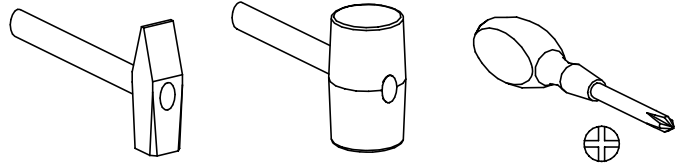
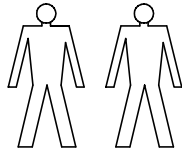

Z-1 St.

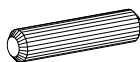

B-9 St.



Y-1 St.

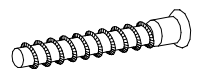

A-12 St.

I

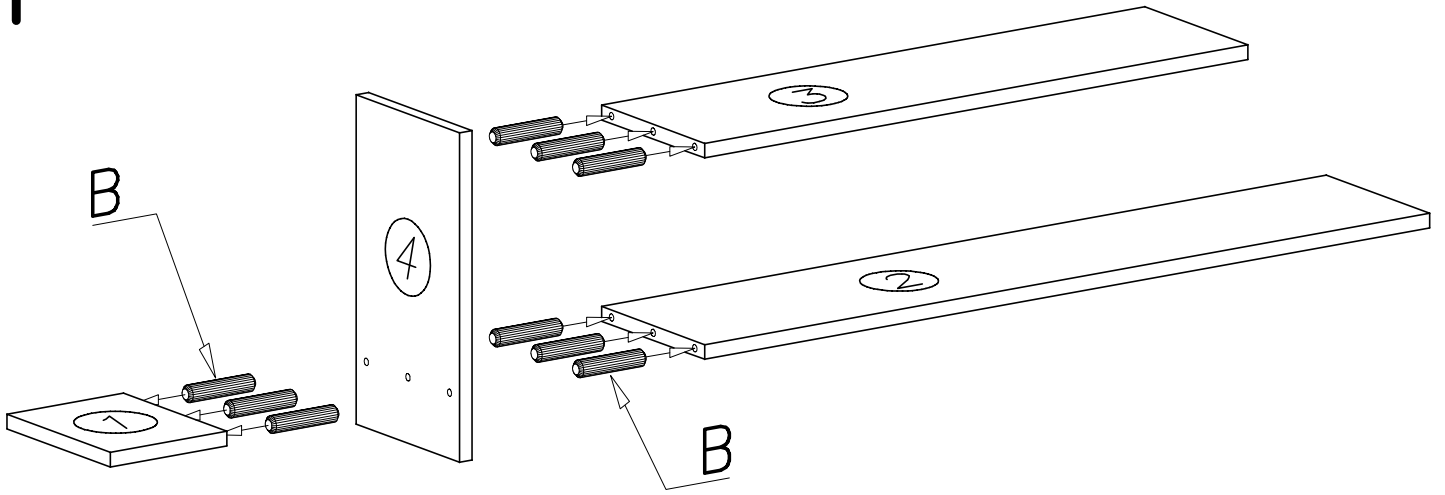

II

