

system PORTOS

P-22

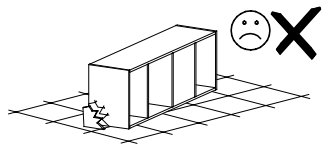

Narzędzia potrzebne do montażu

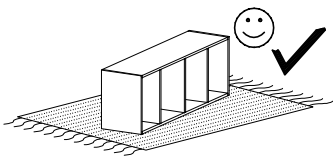
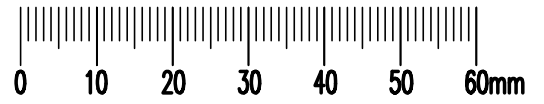
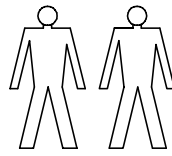
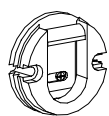
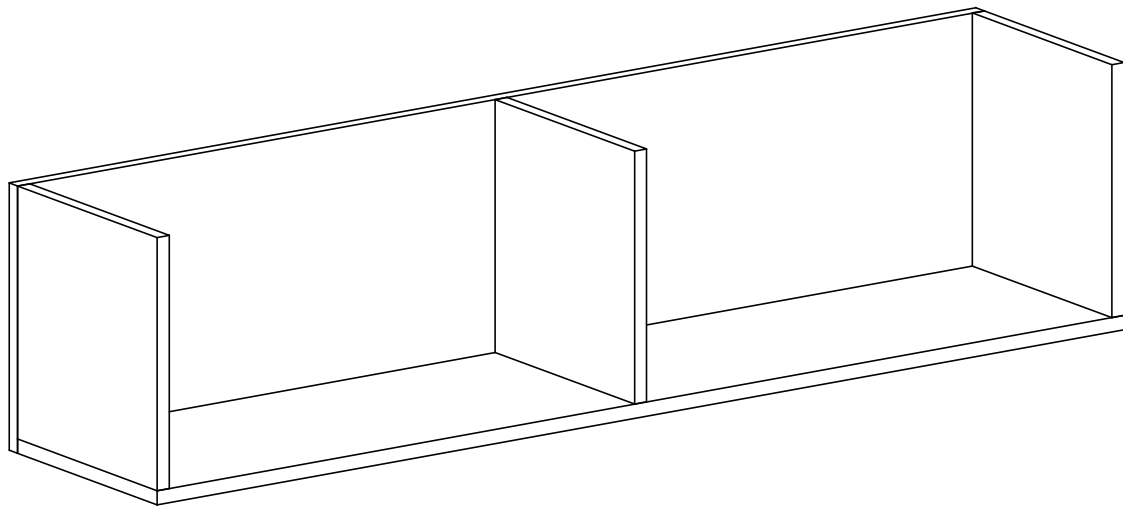
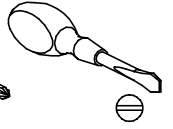
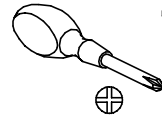
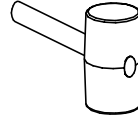
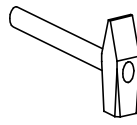

D-2 St.



B-6 St.

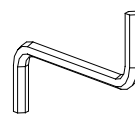

Y-1 St.

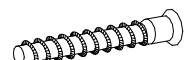

G-8 St.

I

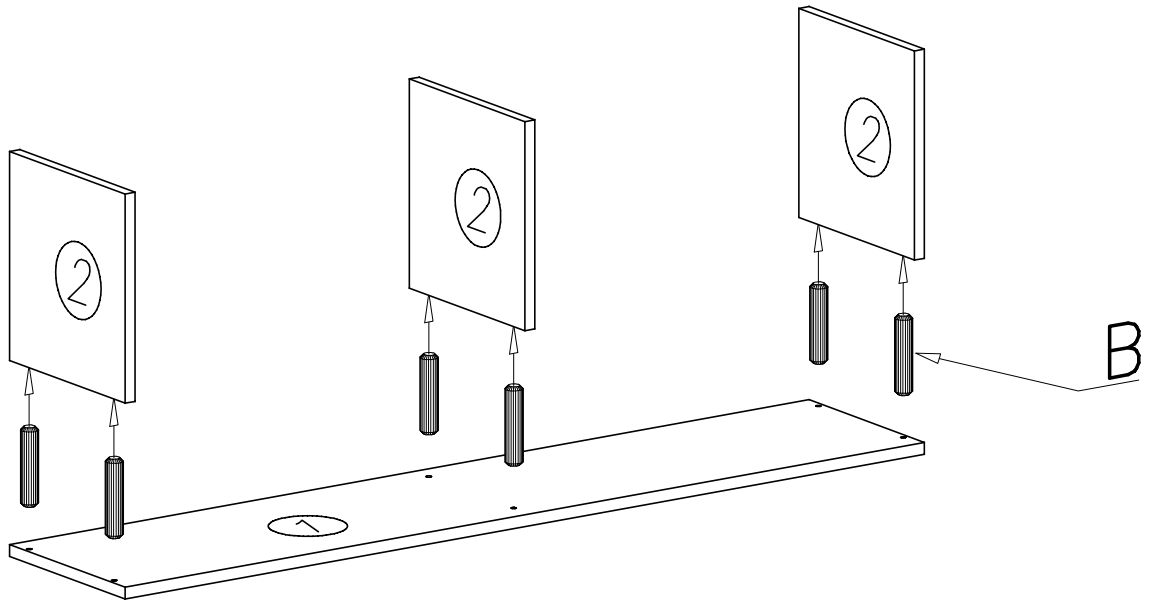

II

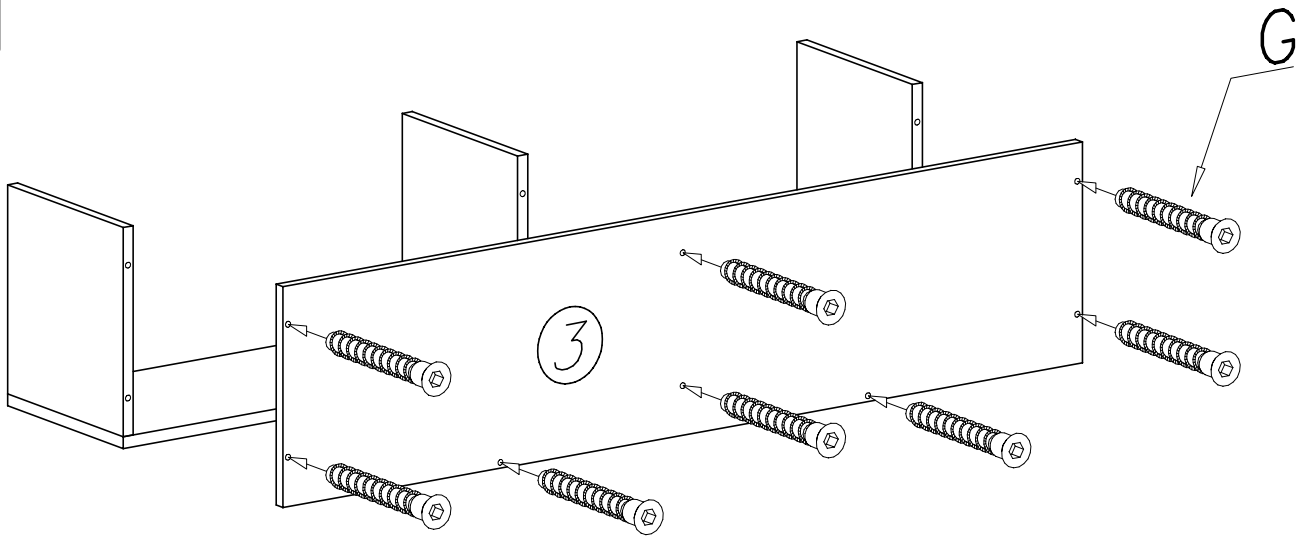

III

