

system PORTOS

P-05

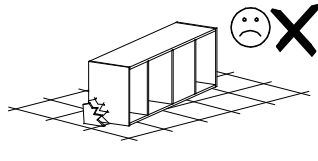

Narzędzia potrzebne do montażu

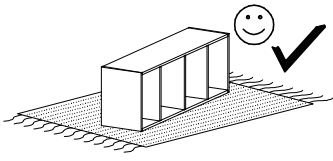
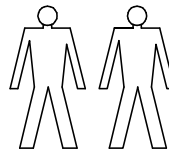
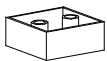
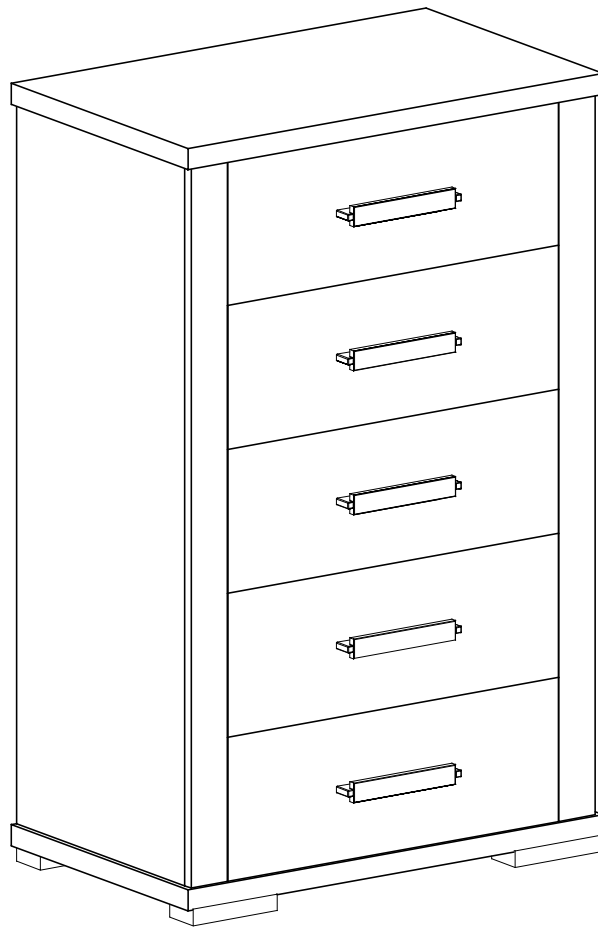
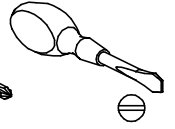
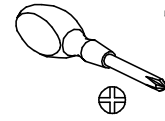
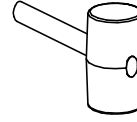
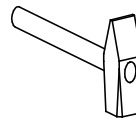

R-2 St.

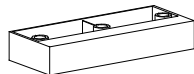

A-2 St.

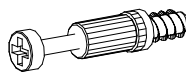

N-24 St.

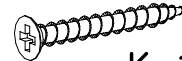

K-10 St.
4x30

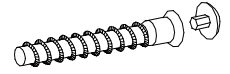

G-20 St.

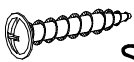

S-10 St.
4x27

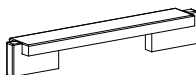

U-5 St.

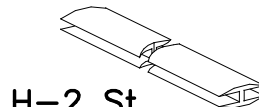

H-2 St.

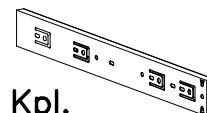

J-5 Kpl.

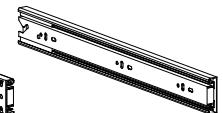

E-80 St.

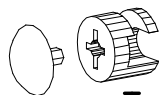

T-24 St.



B-44 St.

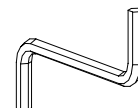

Y-1 St.



Z-60 St.
3,5x16

I

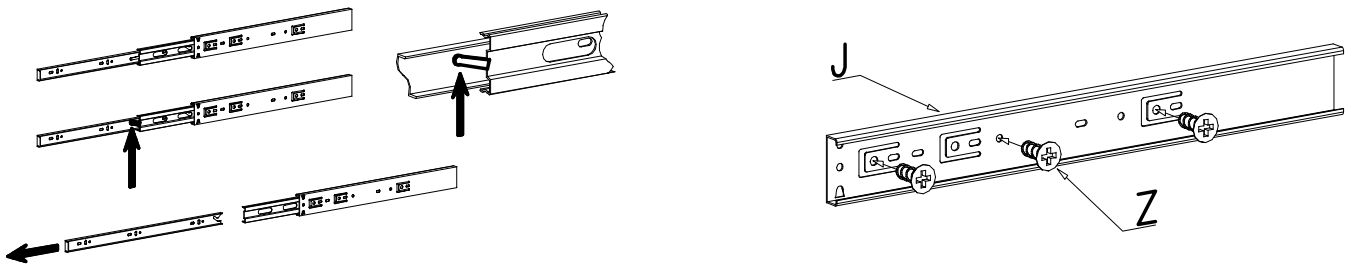
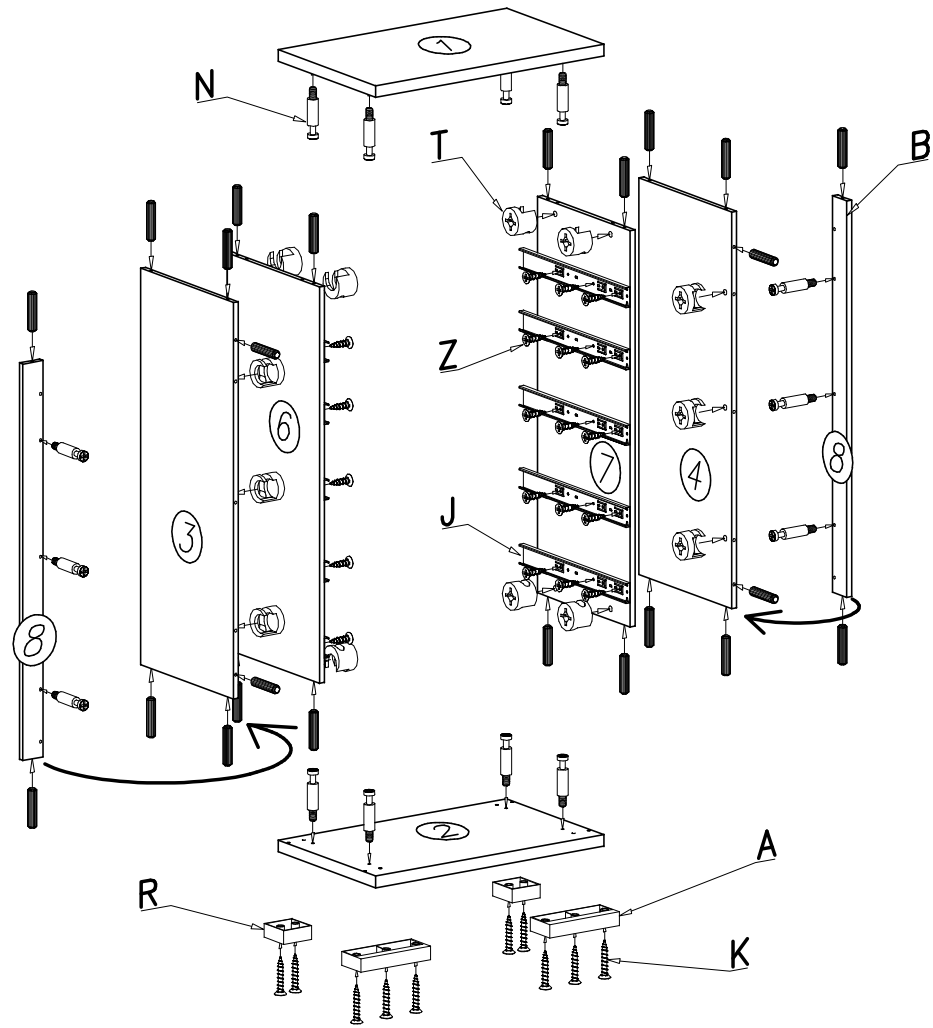

II

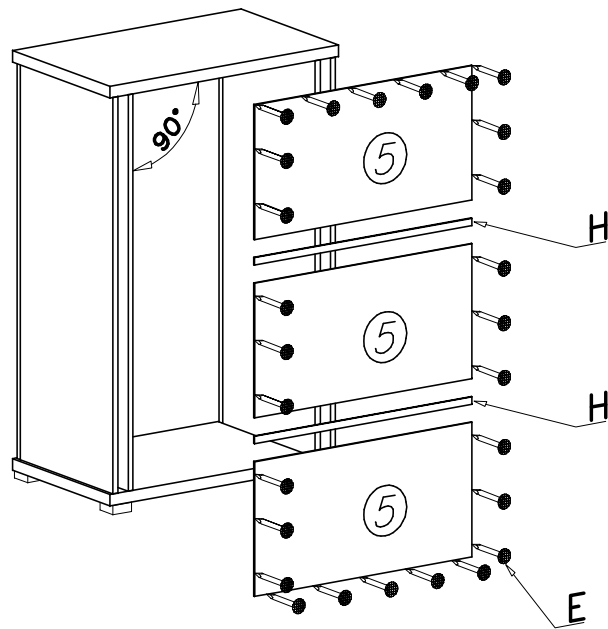

III

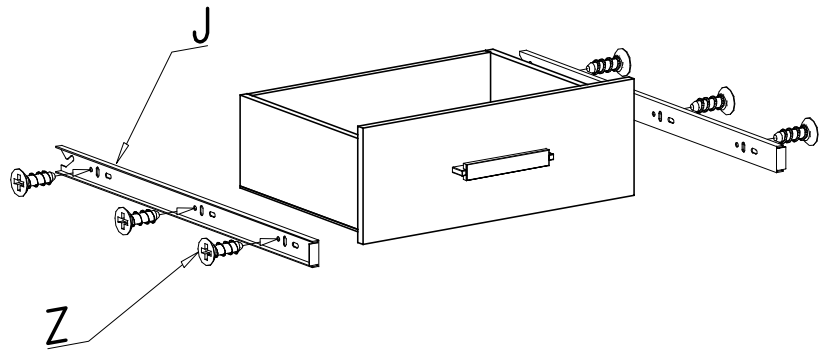
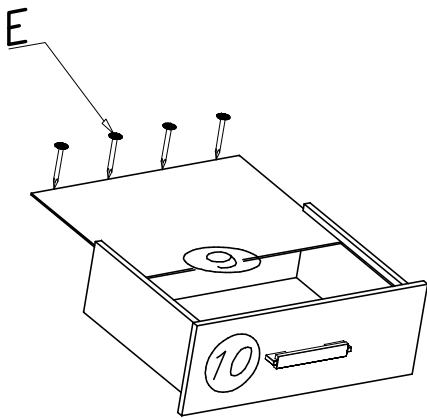
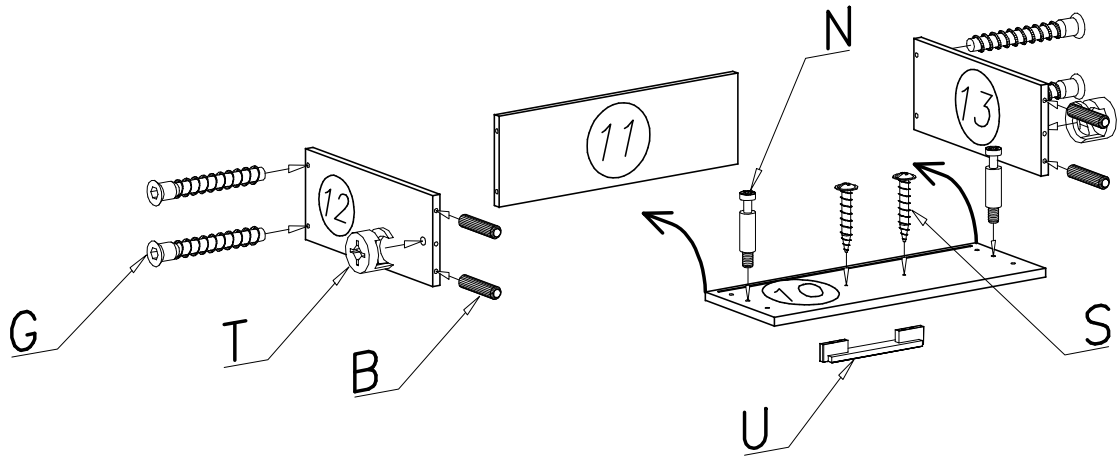

IV

