

# Z1 Z2 Z3

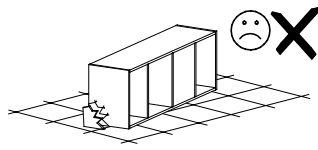

Narzędzia potrzebne do montażu

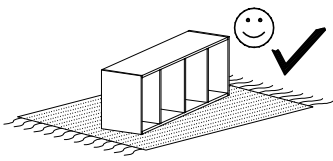
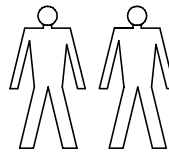
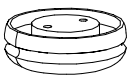
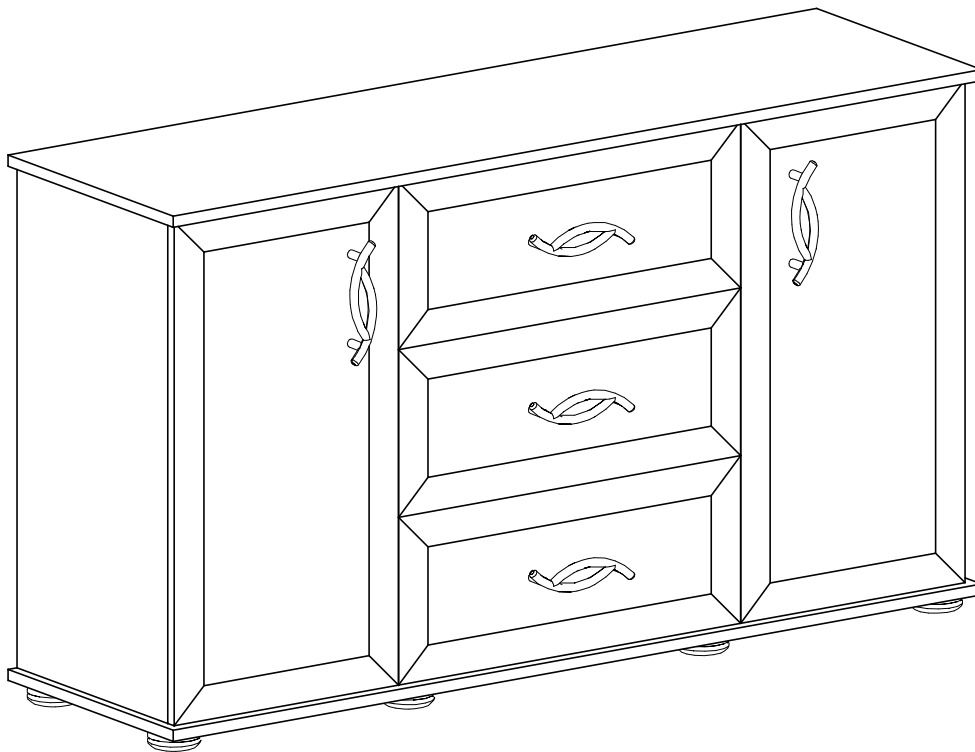
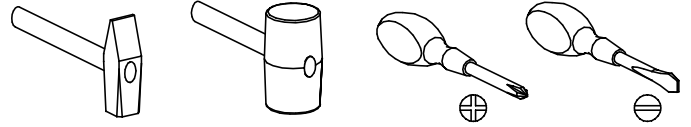

Z-8 St.



E-60 St.

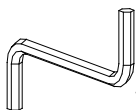

Y-1 St.



U-5 St.



S-10 St.  
4x27

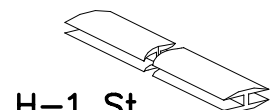

H-1 St.

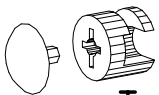

T-22 St.

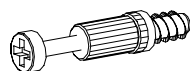

N-22 St.

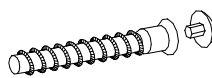

G-12 St.

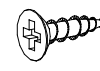

R-48 St.  
3,5x16

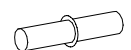

P-8 St.



B-28 St.

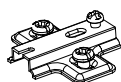

C-4 St.

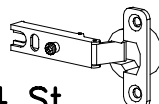

D-4 St.

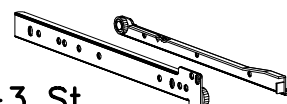

J-3 St.

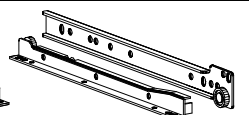

I

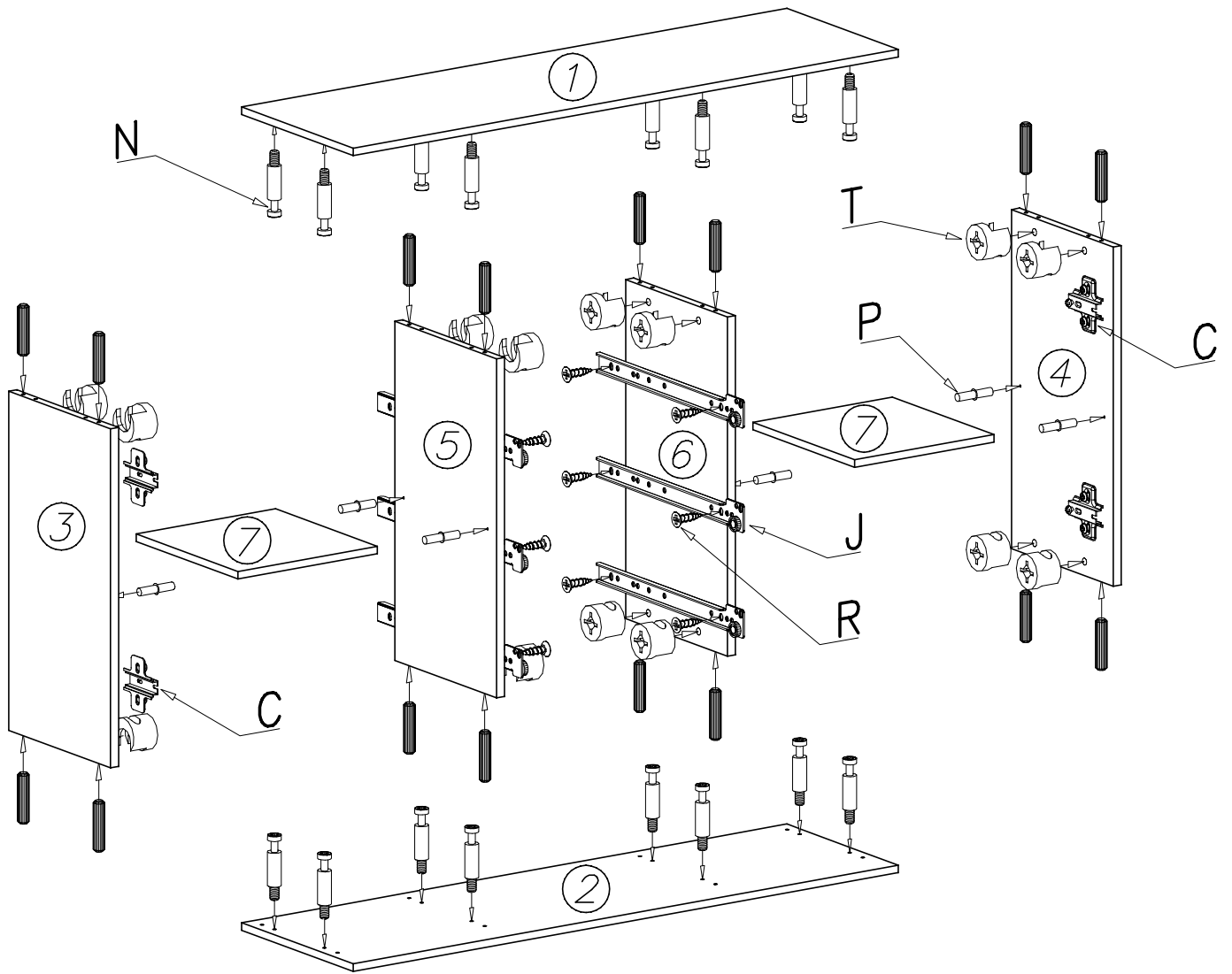

II

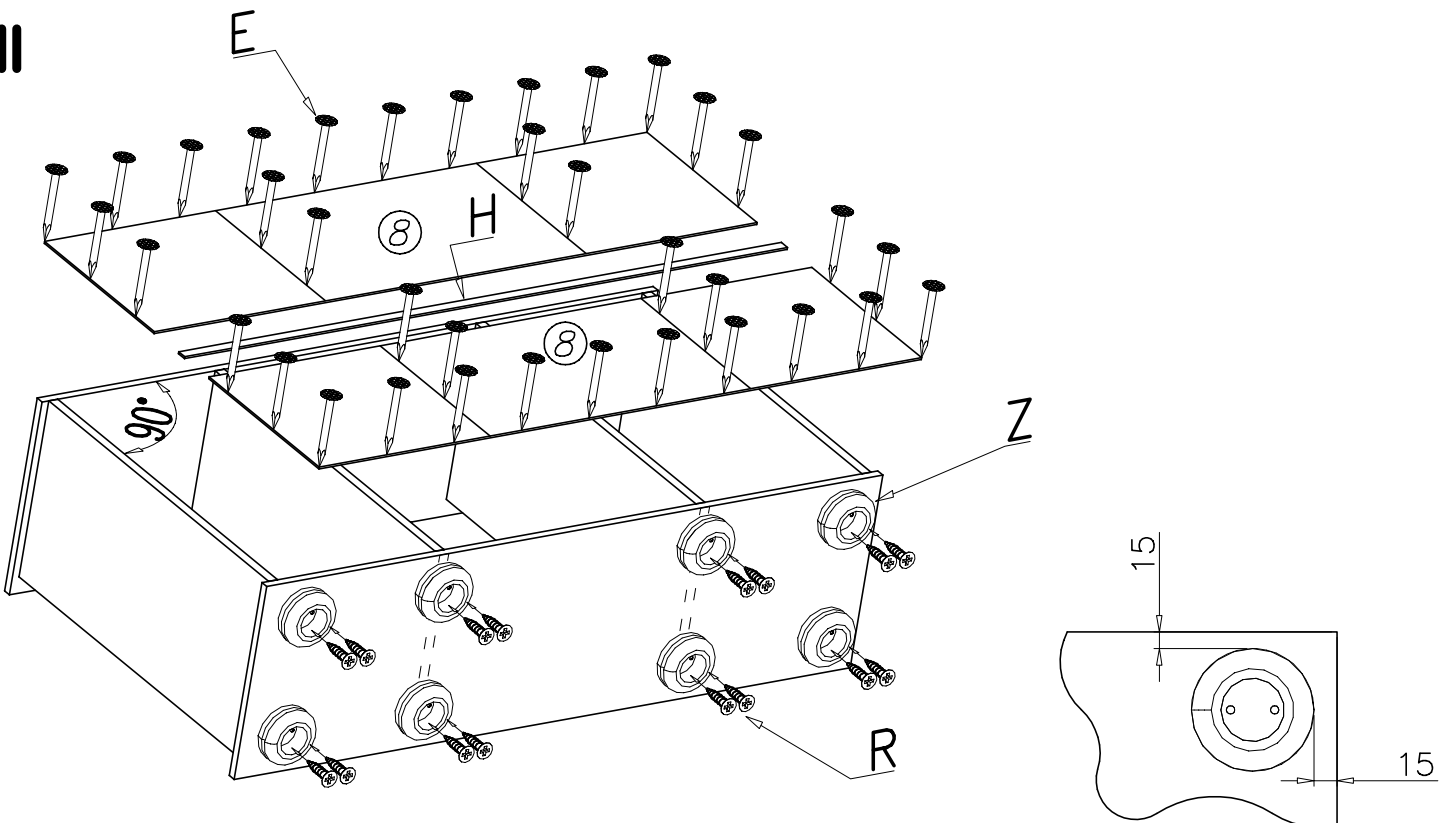

### III

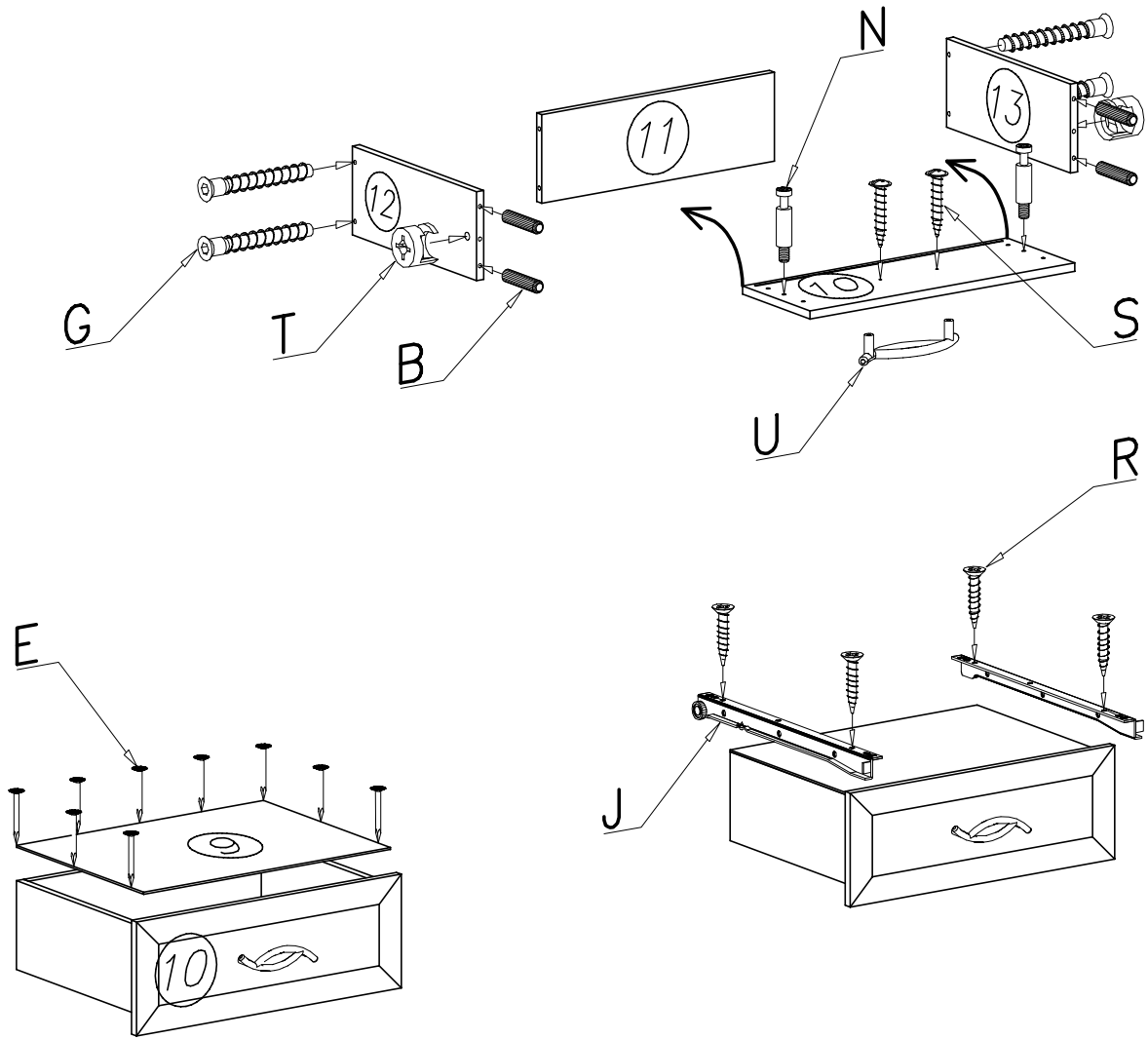

### IV

